

Rohs Compliance

REV	DESCRIPTION	DATE	BY

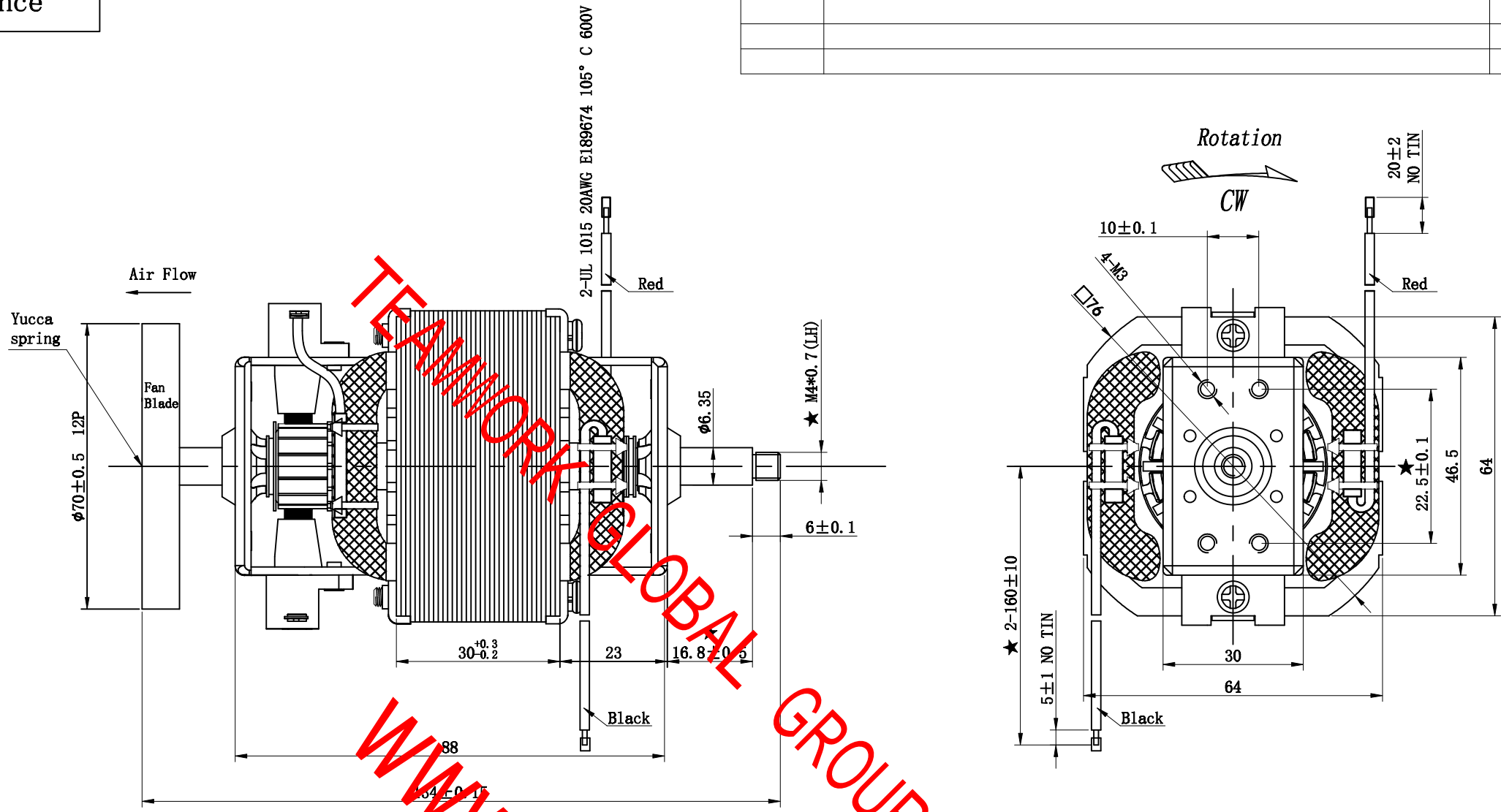

Notes:

1. Voltage with Frequency (电压和频率): 220V/50Hz
2. Rotation (转向): CW
3. No-load Performance (空载性能)
 No-load Speed (空载转速): 19700 ± 15% RPM
 No-load Current (空载电流): 0.8 ± 15% A
 No-load Power (空载功率): 175 ± 15% W
4. On load Performance (负载性能)
 On load Speed (负载转速): 11700 ± 10% RPM
 On load Current (负载电流): 2.03 ± 10% A
 On load Power (负载功率): 425 ± 10% W
5. Temperture Rise (温升): 115K
6. Insulation Grade (绝缘等级): class F
7. Withstand Voltage (耐压): 1800V/2ma/1sec.

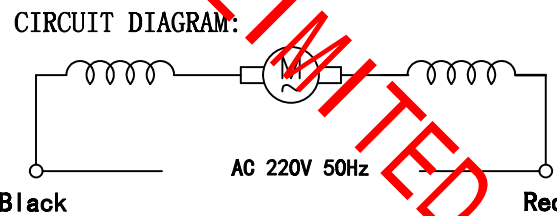

Label content:
 OD-7630M22
 220V/50Hz
 MADE IN CHINA

GENERAL TOLERANCES ISO 2768-m	
Permissible deviations for linear dimensions	
Permissible deviations for basic size range	
>0.5 ...3	>3 ...6
>6 ...30	>30 ...120
>120 ...400	>400 ...1000
>1000 ...2000	>2000 ...4000
m	±0.1 ±0.1 ±0.2 ±0.3 ±0.5 ±0.8 ±1.2 ±2
Permissible deviations for angular dimensions	
Permissible deviations for ranges of lengths in millimeters of the shorter side of the angle concerned	
>10 ...50	>50 ...120
>120 ...400	>400 ...1000
>1000 ...2000	>2000 ...4000
m	±1° ±1° 30' ±0° 20' ±0° 10' ±0° 5'
Permissible deviations for broken edges (external radii chamfer heights)	
Permissible deviations for basic size range	
>0.5 ...3	>3 ...6
>6 ...10	>10 ...15
m	±0.2 ±0.5 ±1

DWN. BY GYZ	CHK. BY ALLEN	APP. BY ADWARD
Date (yy-mm-dd) 2018-03-15	Date (yyyy-mm-dd)	Date (yyyy-mm-dd) 2018-03-15
MATERIAL:		
FINISH:		
General Tolerance ISO 2768-1 Class m (Unless specified) TITLE		
ALL DIMENSIONS ARE IN MILLIMETRES		
SHENZHEN ODIN IMPORT AND EXPORT CO., LTD		OD-7630M22
DWG NO. 7630M22		SHEET 1 OF 1

WWW.TW-MOTOR.COM
 TEAMWORK GLOBAL GROUP LIMITED

Rohs Compliance

REV	DESCRIPTION	DATE	BY

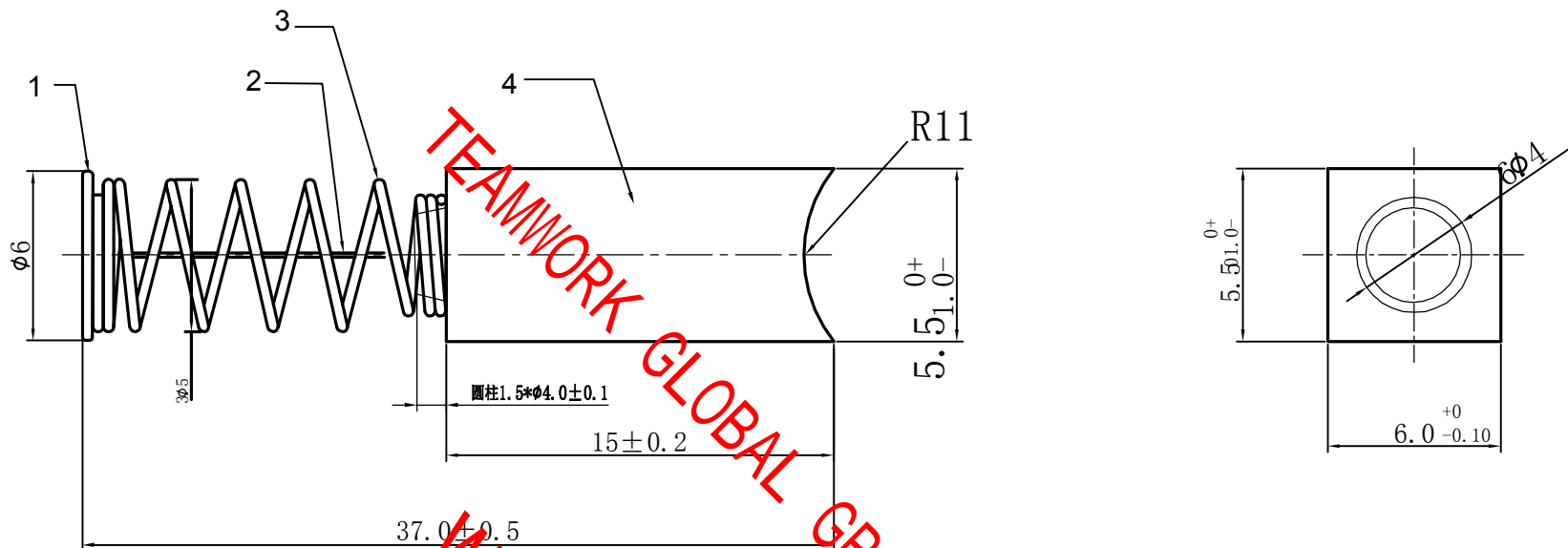

NOTE:

1. Electrical Resistivity ($\mu\Omega\cdot m$): 0.19-0.36;
2. Hardness (HS): 13-24;
3. Volume Density (g/cm^3): 1.9-2.1;
4. Breaking Strength (mpa): 26;
5. Limit Current Density (A/cm^2): 30

4	Brush	JH178	1
3	Spring	$\phi 0.35 \times \phi 5.3 \times H35 \times 12/14$	1
2	Wire	copper $\phi 1.0$	1
1	Contact piece	H62/0.5T	1
序号	名称	规格	数量

GENERAL TOLERANCES ISO 2768-m						
Permissible deviations for linear dimensions						
Permissible deviations for basic size range						
>0.5 ...3	>3 ...6	>6 ...30	>30 ...125	>120 ...400	>1000 ...2000	>200 ...4000
m	±0.1	±0.1	±0.2	±0.3	±0.5	±0.8

DWG. BY GYZ	CHK. BY ALLEN	APP. BY ADWARD
Date (yyymmdd) 2017-12-17	Date (yyymmdd) 2017-12-17	Date (yyymmdd) 2017-12-17
MATERIAL: JH178	SCALE 3:1 <input checked="" type="checkbox"/> NOT SCALE <input type="checkbox"/>	
FINISH:	TITLE CARBON BRUSH	
General Tolerance ISO 2768-1 Class unless specified	DWG NO. 7630M22	
ALL DIMENSIONS ARE IN MILLIMETERS	SHEET 1 OF 1	
SHENZHEN SHENHONG IMPORT AND EXPORT CO., LTD	A	

客戶名稱 (Customer) : CW
 資料檔名 (Filename) : OD-7630M22
 馬達型號 (Motor No.) : OD-7630M22
 額定電壓 (Voltage) : 220V/50Hz
 額定輸出 (Pout Rated) :

馬達溫度 (Temperature) :
 無載轉速 (No-Load R.P.M) :
 無載電流 (No-Load Current) :
 啟動轉矩 (Started Torque) :
 測試日期 (Test Date) : 2017.08.19

	速度 R.P.M.	電 流 Amp	轉 矩 Kgcm	效 率 Eff	輸出功率 Wout	輸入功率 Win
無載狀態 (No-Load)	18493	0.697	0.192	0.2001	38.456	174.612
最大扭力 (Max-Torque)	8815	2.705	4.219	0.5930	362.8688	610.298
最大效率 (Max-Efficiency)	11641	1.911	2.414	0.6698	287.6490	440.336
最大輸出功率 (Max-Pout)	8815	2.705	4.219	0.5930	362.8688	610.298

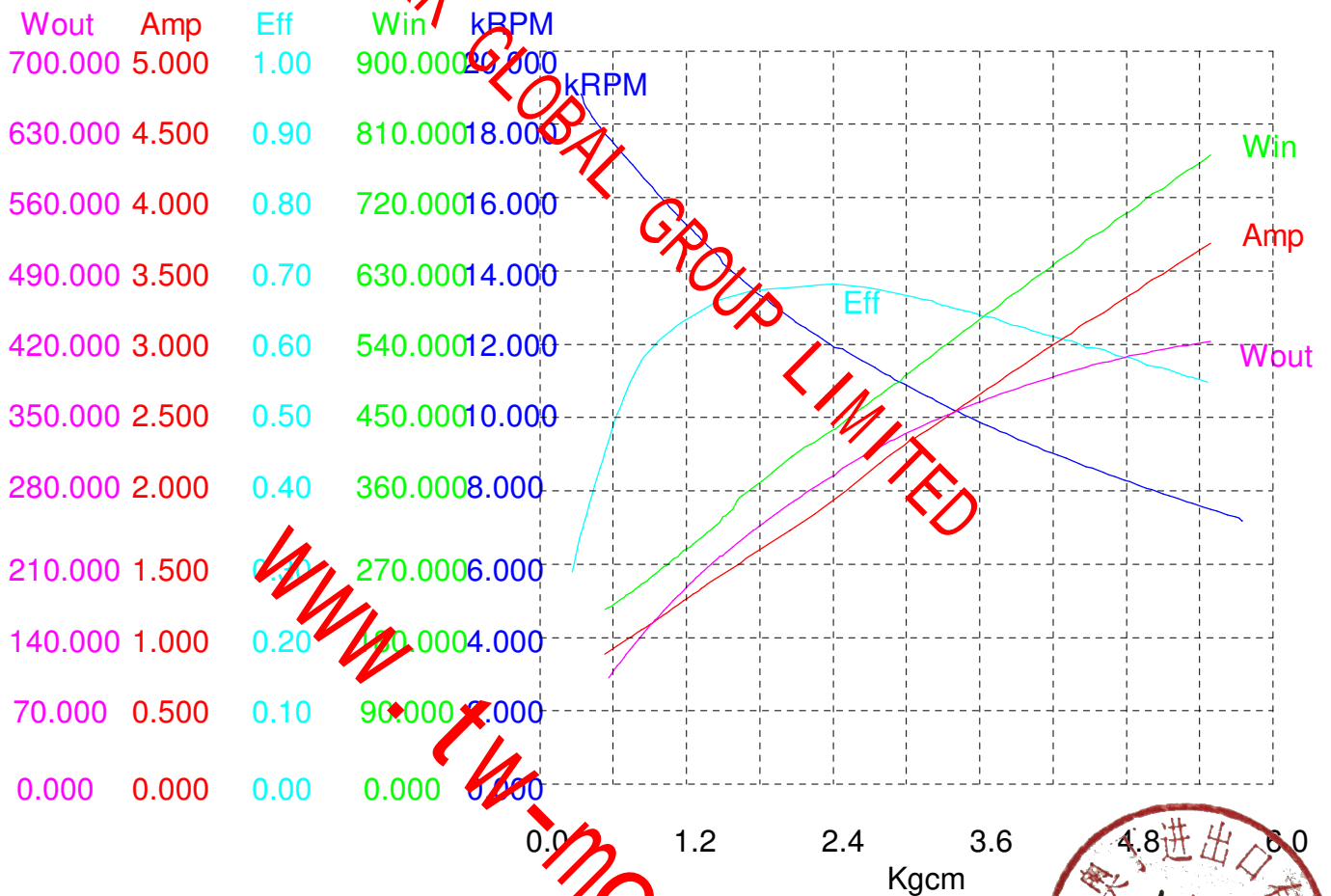

www.hele-motor.com

客戶名稱 (Customer) : CW
 資料檔名 (Filename) : OD-7630M22
 馬達型號 (Motor No.) : OD-7630M22
 額定電壓 (Voltage) : 220V/50Hz
 額定輸出 (Pout Rated) :

馬達溫度 (Temperature) :
 無載轉速 (No-Load R.P.M) :
 無載電流 (No-Load Current) :
 啟動轉矩 (Started Torque) :
 測試日期 (Test Date) : 2017.08.19

項次 Item	電 流 Amps	電 壓 Volts	輸入功率 Win	速 度 Speed	轉 矩 Kgcm	效 率 Eff	馬 力 HP	輸出功率 Wout	功 因 PF
1	0.697	220.20	174.612	18493	0.192	0.2001	0.076	38.4560	0.987
2	0.802	220.29	182.062	18384	0.221	0.3398	0.095	50.7105	0.984
3	0.855	220.19	200.299	17563	0.466	0.4246	0.118	78.8829	0.985
4	0.951	220.15	220.496	17325	0.575	0.4548	0.137	92.9637	0.983
5	1.008	220.14	231.331	17005	0.625	0.4386	0.141	95.8463	0.980
6	1.057	220.14	238.721	16624	0.658	0.4395	0.150	101.9057	0.989
7	1.114	220.25	247.174	16163	0.768	0.4850	0.170	125.6742	0.977
8	1.141	219.84	258.774	15795	0.846	0.4996	0.180	125.3360	0.976
9	1.206	219.95	270.538	15486	0.941	0.5485	0.199	141.2823	0.977
10	1.256	219.81	280.713	15239	1.065	0.5698	0.219	155.7583	0.975
11	1.305	219.80	292.612	14785	1.165	0.5850	0.237	169.2861	0.973
12	1.379	219.90	303.862	14481	1.281	0.6018	0.254	180.1818	0.971
13	1.444	220.05	320.597	14134	1.446	0.6188	0.272	200.6480	0.979
14	1.525	220.05	336.936	13785	1.554	0.6238	0.287	208.5485	0.970
15	1.606	220.18	353.476	13386	1.687	0.6265	0.304	221.1772	0.966
16	1.684	220.17	370.165	13085	1.836	0.6289	0.322	230.1962	0.965
17	1.711	220.20	387.925	12889	1.960	0.6387	0.341	251.1258	0.965
18	1.758	220.19	410.728	12356	2.198	0.6468	0.356	262.7480	0.963
19	1.852	220.10	431.363	11880	2.314	0.6528	0.372	275.6016	0.963
20	1.911	219.94	440.336	11641	2.414	0.6698	0.387	287.6490	0.963
21	1.943	219.92	475.907	11289	2.593	0.6496	0.403	292.8812	0.960
22	1.983	219.91	500.360	10945	2.779	0.6384	0.420	304.9418	0.959
23	2.065	219.67	527.959	10277	3.087	0.6286	0.441	308.3574	0.958
24	2.139	219.66	536.725	9955	3.298	0.6155	0.455	312.8664	0.955
25	2.276	219.70	550.457	9605	3.539	0.6090	0.471	321.0360	0.953
26	2.328	219.69	570.030	9271	3.823	0.6053	0.487	332.5161	0.952
27	2.574	219.82	595.099	8940	4.042	0.6039	0.500	345.5357	0.950
28	2.705	219.97	610.298	8815	4.219	0.5930	0.514	362.8688	0.947



www.tw-motor.com

Rohs Compliance

REV	DESCRIPTION	DATE	BY

FEDERAL BANGKOK MODEL:OD-7630M22 P/O.No.XXXXXXXXXX PART CODE:XXXXXXXXXXXX C/ NO. XXX/XXX MADE IN CHINA	G.W.: 27.2 KGS N.W.: 26.2 KGS CTN.:XXXXXXXXXXCM	FEDERAL BANGKOK MODEL:OD-7630M22 P/O.No.XXXXXXXXXX PART CODE:XXXXXXXXXXXX C/ NO. XXX/XXX MADE IN CHINA	Quantity: 30 PCS
---	---	---	----------------------

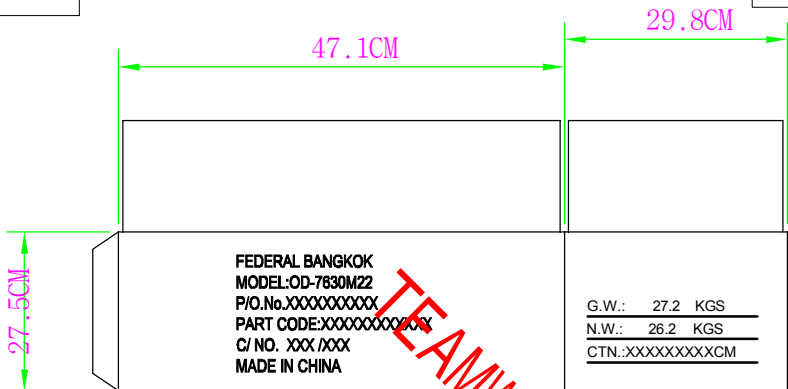

Carton size:47.1*29.8*27.5cm

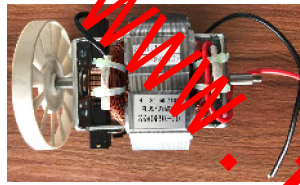
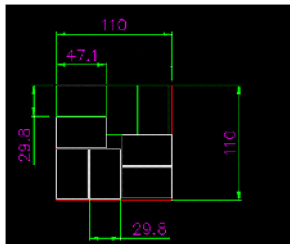

Net weight:
873±20g



1 layer /10 pcs;
 3 layers /1 ctn;
 30 pcs /1 ctn;
 G.W:27.2kg /1 ctn

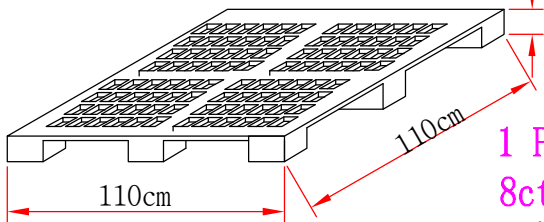

1 Pallet layer =8ctn
 8ctn X 7 layer=56ctn
 20' fcl container=560ctn
 560ctn X 30pcs/ctn=16800pcs
 1X20FCL:16800PCS

GENERAL TOLERANCES ISO 2768-m					
Permissible deviations for linear dimensions					
Permissible deviations for basic size range					
≤ 0.5	>3	>6	>30	>120	>400
±0.1	±0.15	±0.2	±0.3	±0.5	±0.8
Permissible deviations for angular dimensions					
Permissible deviations for ranges of angles in millimeters of the shorter side of the angle concerned					
±1'	±1'	±1'	±1'	±1'	±1'

DWG. BY:GYZ	CHK. BY:ALLEN LEE	APP. BY:ADWARD
Date(yy/mm/dd):2017-12-17	Date(yyyymmdd)	Date(yyyymmdd) 2017-12-17
MATERIAL:		<input checked="" type="checkbox"/> SCALE 3:1 <input type="checkbox"/> NOT SCALE
FINISH:		<input checked="" type="checkbox"/> A4 <input type="checkbox"/> NOT SCALE
General Tolerance ISO 2768-1 Class m (Unless specified)		TITLE
ALL DIMENSIONS ARE IN MILLIMETERS		OD-7630M22
SHENZHEN ODIN IMPORT AND EXPORT CO.,LTD		DWG NO.
		OD-7630M22
		SHEET 1 OF 1

TEAMWORK GLOBAL GROUP LIMITED
 www.teamwork-motor.com



Shenzhen Odin Import and Export Com.,Ltd

Outgoing Inspection Sheet

Customer :	Federal	Sample No. :	17070301	Sample Quantity :	5PCS	Test date :	2017.12.17		
Motor type:	OD-7630M22	Rated Volt. :	220v	Test Freq.:	50Hz				
No.	Inspecting Item	Inspecting Standards	1	2	3	4	5	6	
1	No-load Current	0.8A±15%	0.85	0.79	0.81	0.8	0.82	0.76	
2	No-load Speed	9700RPM±15%	21256	20465	21330	21395	20560	20300	
3	No-load Power	175W±15%	185	172	182	181	179	166	
4	Direction(CW/CCW)	CW	CW	CW	CW	CW	CW	CW	
5	Load Current(A)	2.03A±10%	2.07	2.06	2.04	2.05	2.06	2.1	
6	Load Speed(RPM)	11700RPM±10%	11850	11750	11720	11680	11785	11500	
7	Load Power(W)	425W±10%	433	430	427	428	431	410	
8	Motor Virtual Space(mm)	0.5-1.0	0.68	0.75	0.85	0.8	0.78	0.75	
9	Wire Length	160mm±10	160	161	160	160	161	168	
10	Spark	1.5Level	OK	OK	OK	OK	OK	OK	
11	Noise (Shaft length of 100cm)	<85dBA	75	74.5	73.5	75.5	76.5	73	
12	Vibration	♦ 20s/mm	17	16	16.5	17.1	17.5	15	
13	High Volt.Test(V/Ma/S)	1800V/2mA/1sec	OK	OK	OK	OK	OK	OK	
14	Shaft E tension Length	16.8mm±0.5	16.8	17.1	16.8	16.7	17.0	16.5	
15	Visual Inspection	As inspecting standard	OK	OK	OK	OK	OK	OK	
Remark									
Conclude: ACC			Inspector Sea Xiang	Checked Allen	Approved Mr Edward	Date 2017/12/17			
<input type="checkbox"/> ACC <input type="checkbox"/> REJ									



TEAMWORK
 GLOBAL
 WWW.TEAMWORKMOTOR.COM
 TEAMWORK MOTOR LIMITED